



MULTI SCREEN® MS 4200



ON A GREEN MISSION

soil



construction waste



green waste



wood chips



sand & gravel



recycling



stones



compost





MULTI SCREEN® MS 4200

OPTIONS



Ripped belt for feeder or fine fraction



Special lacquering

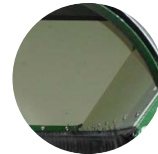

Abrasion plates for the feeder



Hydraulic stone grid with slide



Remote control



Hydraulic support leg (requires remote control)



Permanent drum magnet with slide



Outer wire screens optional 2 to 80 mm



Bisection of the inner trommel approx. 75 x 75 mm



Extended conveyor belt for middle fraction



Inner wire screens optional 2 to 80 mm



Extended conveyor belt for coarse fraction



Rip blades

MORE OPTIONS



different trommels:
- conic
- single
- punched
- and more



Reversible cooler for hydraulic oil cooler incl. reverse control and reversible cooler for diesel engine



Roof for double trommel and cleaning brush



accessory shoe (in-house transport, do not use on public roads)



TopSpin PreCleaner



Flood lamps



Additional connector for hydraulic connection



MULTI SCREEN® MS 4200

TECHNICAL DESCRIPTION 1

■ Base frame:

longitudinal beam: double T-profile steel,
height approx. 300 mm
chassis: 2 x 9 t Leaf spring axles by
Gigant
underrun and side
protection
tires: 4 x 385 / 55 R 22,5
brake: two circuit compressed air
breaks with ABS
lighting: LED light strip,
marker lights are flashing
Remodeling on 25 km/h- axle possible

■ Feeder:

cubage: 5.5 m³
loading height: 3,120 mm
loading length: 3,650 mm

■ Feeding belt:

belt width: 1.000 mm
belt length: 3.600 mm
belt type: plain
speed: adjustable
profile belt: optional

■ Double trommel:

surface:
inner: 15.7 m²
outer: 16.0 m²
drum diameter: 1,500 mm (inner)
drum diameter: 2,000 mm (outer)
drum length: 4,200 mm
trommel drive: direct over chain and chain
wheel

■ Mesh sizes:

inner: 80 x 170 mm (standard)
outer: exchangeable wire screens,
2 – 80 mm
screen change function by means of remote
control

■ Cleaning brush:

diameter: 500 mm, with own drive

■ Conveyor belt fine fraction:

belt width: 650 mm
hydraulic foldable
drop off side: left
drop off height: approx. 3,300 mm

■ Belt beneath double trommel, fine fraction

belt width: 1,100 mm

■ Conveyor belt middle fraction:

belt width: 650 mm
hydraulic foldable
drop off side: right
drop off height: approx. 2,300 mm (standard)
approx. 3,300 mm
(extended conveyor belt)

■ Conveyor belt coarse fraction:

belt width: 800 mm
hydraulic foldable
drop off side: rear
drop off height: approx. 2,140 mm (standard)
approx. 3,000 mm
(extended conveyor belt)

■ Screen material:

sand, saw dust, wood chips, compost, soil, coal and
cinder, construction waste and recycling materials,
stones and gravel sand

■ 3 fractions:

fine fraction: 2 - 80 mm, on demand
middle fraction: 2 - 80 mm up to 170 mm
coarse fraction: ex 170 mm (standard)

■ Remodeling to 2 product trommel possible:

shortened inner trommel, omission of belt of coarse product
shortened inner trommel, omission of middle product,
widened & extended conveyor of coarse product
4.500 x 1.000 mm
single trommel, omission of middle product, widened &
extended conveyor of coarse product 4.500 x 1.000 mm



MULTI SCREEN® MS 4200

TECHNICAL DESCRIPTION 2

Chassis options:

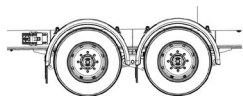

On wheels (standard)



Track drive
(requires remote control Maxi)



On skids

Drive concept:

diesel-hydraulic

diesel engine: CATERPILLAR C3.6 74,5 kW
2.400 U/m.

emission std.: EU stage V / EPA / CARB
Tier 4 Final

drive: Oilpumps & oilmotors

tank capacity: 200 l / 20 l AdBlue

diesel-electric

emission std.: EC-NRMM Stage III B

drive: Current synchron generator
& electric motors

tank capacity: 200 l

external power supply possible (depending on country specific current / in combination with diesel-electric or electric drive)

electric

connected load: approx. 50 kVA

Weight: approx. 15,000 kg
(standard equipped machine)

Pulling device:
drawbar eye Ø 50 mm, according to ISO 1102

Dimensions:

Transportation:

Standard	ext. conveyor belt
length: 10.455 mm	10.658 mm
height: 3.950 mm	3.980 mm
width: 2.550 mm	2.550 mm

Service:

Standard	ext. conveyor belt
length: 12.113 mm	13.568 mm
width: 11.038 mm	11.038 mm
height: 3.950 mm	3.950 mm

Capacity: 20 – 120 m³/hour,
depending on condition of material,
mesh size and feeding

Colour / Coats:

polyurethane one-coat topcoat
silo, engine cover and side covers: RAL 6001 green
chassis, screening drum: RAL 7022 umbra grey
conveyor belt frame: hot galvanized



MULTI SCREEN® MS 4200

DIMENSIONS EXTENDED CONVEYOR BELTS

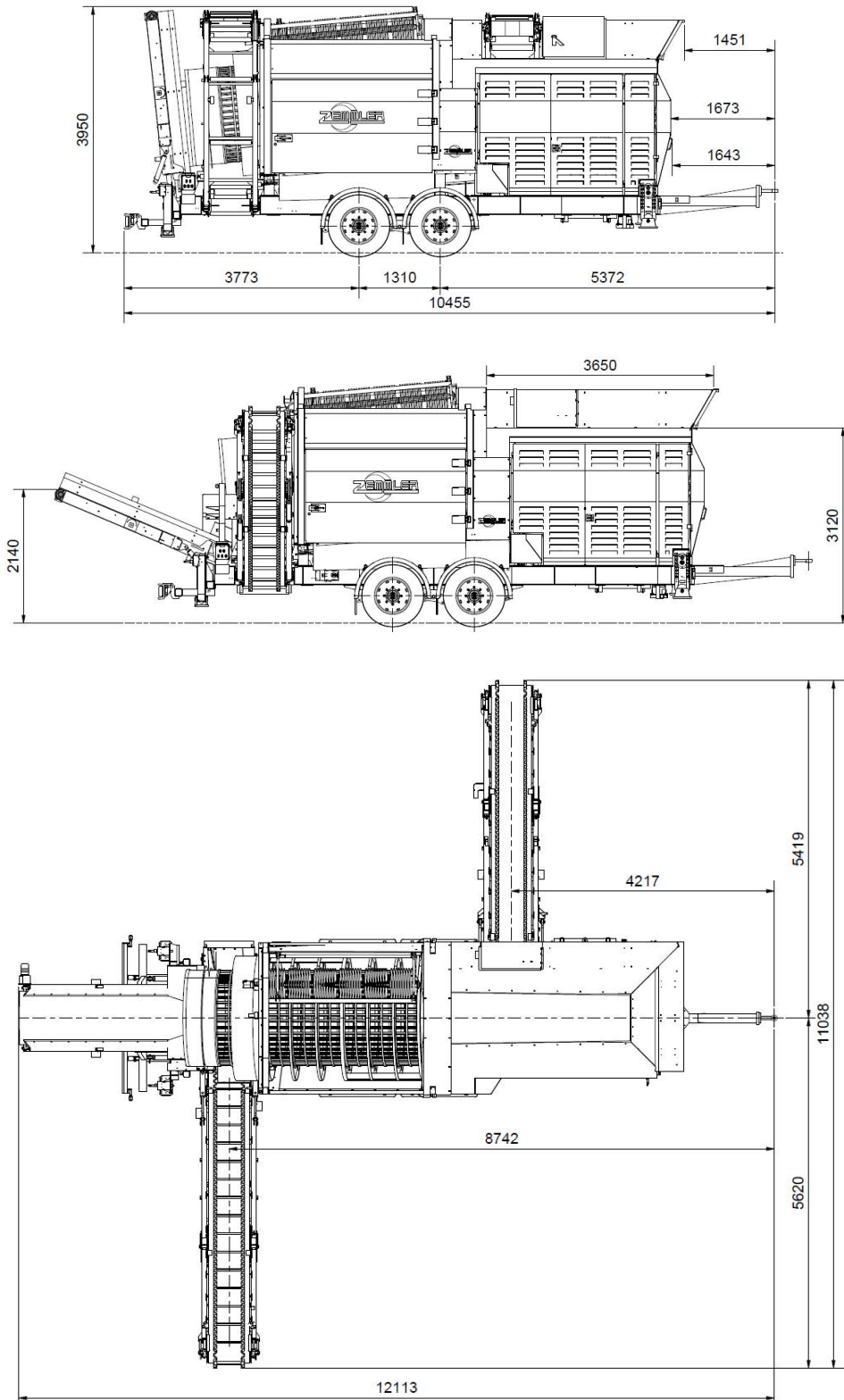



MULTI SCREEN® MS 4200

DIMENSIONS EXTENDED CONVEYOR BELTS

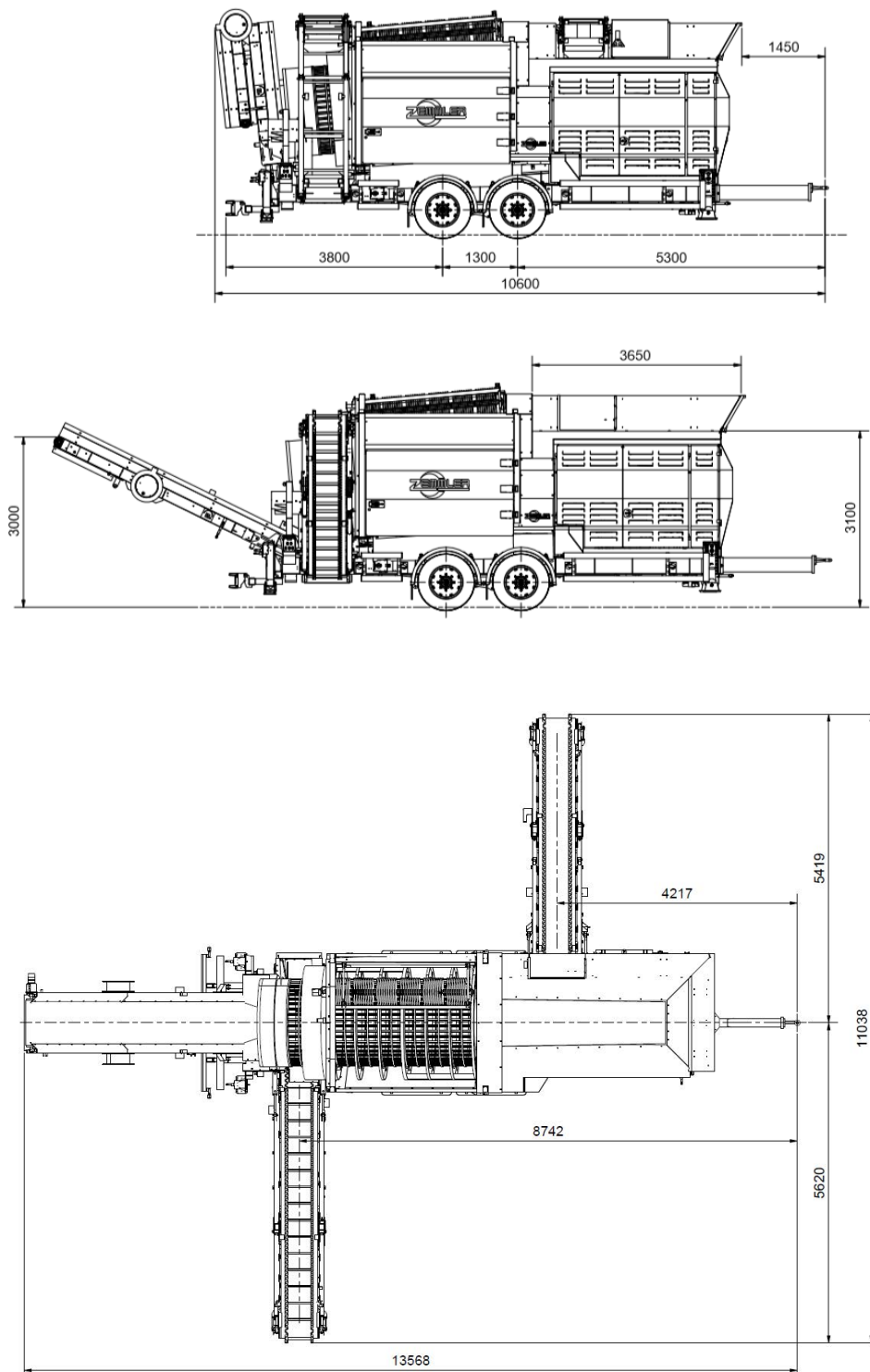



MULTI SCREEN® MS 4200

DIMENSIONS EXTENDED CONVEYOR BELTS

